

# To Design High CMRR, High Slew rate Instrumentation Amplifier using OTA and CDTA for Biomedical Application

Shruti Jain

Electronics and Communication Engineering Department, Jaypee  
University of Information Technology, Wagnaghat, Solan, H.P.,  
India.

Email : jain.shruti15@gmail.com

**Abstract-** *In today's world operational amplifier is used in lot of application. The techniques for achieving high slew rate and high CMRR is by cascading the transistors. This paper focus is on understanding of Operational Trans conductance Amplifier (OTA) and Current Differencing Trans conductance Amplifier (CDTA) with its application as Instrumentation Amplifier (IA) for Biomedical application. We have designed Instrumentation Amplifier using CDTA to obtain high common mode rejection ratio (CMRR), high slew rate in comparison with OTA using PSPICE software.*

**Keywords—** OTA, CDTA, IA, CMRR

## I. Introduction

Most biomedical engineers learn the physical sciences first in the context of traditional engineering, physics, or chemistry [1]. Every instrumentation system has at least some of the functional components shown in Figure 1. The primary flow of information is from left to right. The major difference between this system of medical instrumentation and conventional instrumentation systems is that the source of the signals is living tissue or energy applied to living tissue.

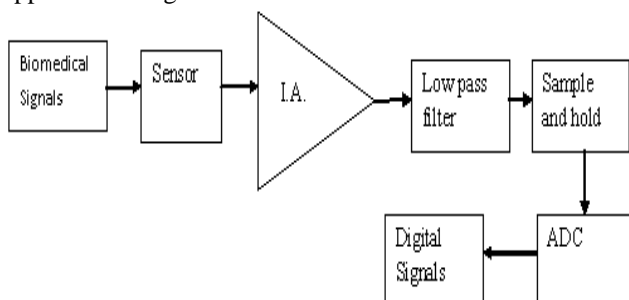

Fig 1 : Block of biomedical electronics detecting system [1]

The physical quantity, property, or condition that the system measures is called the measurand. The accessibility of the measurand is important because it may be internal (blood pressure), it may be on the body surface (electrocardiogram potential), it may emanate from the body (infrared radiation), or it may be derived from a tissue sample (such as blood or a biopsy) that is removed from the body. Generally, the term transducer is defined as a device that converts one form of energy to another. A sensor converts a physical measurand to an electric output. Usually the sensor output cannot be directly coupled to the display device. The input preamplifier stage carries out the initial amplification of the biomedical application like ECG. This stage should have very high input impedance and a high

common-mode-rejection ratio (CMRR). A typical preamplifier stage is the differential amplifier that consists of three operational amplifiers (op amps) i.e. Instrumentation amplifier (IA). After IA, low pass filter is used. The circuitry of this block contains a barrier to the passage of current from the power line (50 or 60 Hz), then the signal is digitized so as to used for recording.

Portable Electrocardiogram (ECG) monitoring devices are used by many families for the purpose of home care. In an ECG system, Instrumentation Amplifier (IA) is an important element to read the ECG signals. Several prior IAs used an HPF with an off-chip capacitor to meet the demands of an ECG system but they caused the increase of area cost. By contrast, this paper proposes a high performance IA with a higher CMRR and high slew rate using OTA and CDTA.

## II. Basic Transconductance Amplifier

There are different types of Trans conductance amplifiers. In this paper we study only two i.e. Operational Trans Conductance Amplifier (OTA) and Current Differencing Trans Conductance Amplifier (CDTA).

**2.1 Operational trans conductance amplifier :** The operational trans conductance amplifier (OTA) is a fundamental building block in analog design process and its performance characteristics are the foundation of system level characteristics. The OTA employs a differential input pair and current mirrors. The OTA is an amplifier whose differential input voltage produces an output current. Thus, it is a voltage controlled current source (VCCS). There is an additional input for a current to control the amplifier's Trans conductance. The OTA is similar to a standard op amp in that it has a high impedance differential input stage and may be used with negative feedback [2, 3]. The OTA has two attractive features: its Trans conductance can be controlled by changing the external dc bias current or voltage, and it can work at high frequencies. In recent years, OTA-based high frequency integrated circuits, filters and systems have been widely investigated. The equation is:

$$I_{out} = g_m(V_{1+} - V_{1-})$$

where,  $V_{1+}$  is Non inverting input,  $V_{1-}$  is Inverting input,  $I_{out}$  is output current. By taking the pre-computed difference as the input

$$I_{out} = g_m V_{in}$$

with the ideally constant trans conductance  $g_m$  as the proportionality factor between the two, the trans conductance is

also a function of the input differential voltage and dependent on temperature. Fig 2 shows the equivalent diagram of OTA

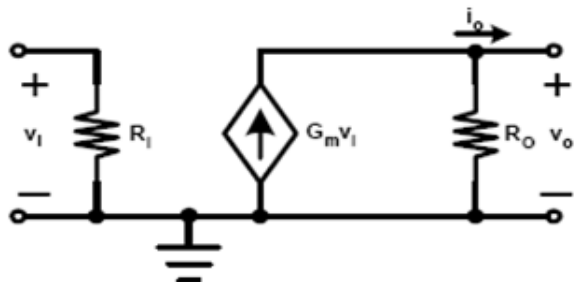

Figure 2: Equivalent Circuit of OTA

An ideal OTA has two voltage inputs with infinite impedance (no input current). The common mode input range is also infinite, while the differential signal between these two inputs is used to control an ideal current source (i.e. the output current does not depend on the output voltage) that functions as an output. The proportionality factor between output current and input differential voltage is called trans conductance. The OTA converts an input voltage to an output current relative to a trans conductance gain parameter.

The basic circuit diagram (shown in Fig 3) is of two stages OTA. In which M1 and M2 use for differential input pair and M3 and M4 forms current mirror. The bias conditions are that each M1 to M8 should remain in saturation for all possible values of the input common-mode voltage and the output voltage.

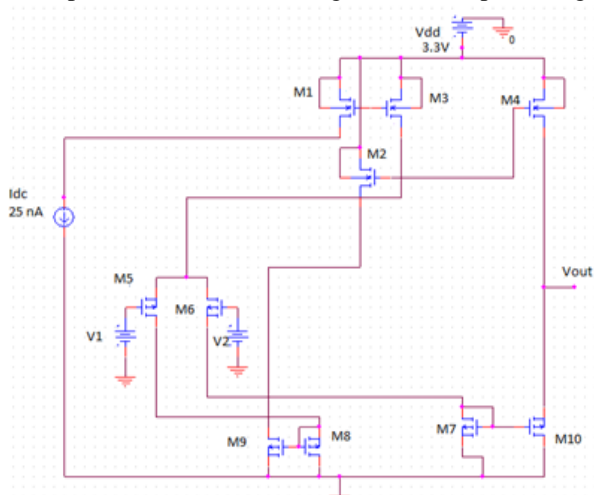

Figure 3: Diagram of Operational Trans conductance Amplifier

Disadvantages of OTA : The conventional OTA therefore suffers the consequence that high speed OTA requires large bias currents which leads to large static power dissipation. The wireless and battery powered systems require high slew rates and higher gain bandwidth values with low power dissipation. These requirements are difficult to achieve with class A structures such as the conventional OTA.

### 2.2 Current differencing Trans conductance amplifier (CDTA) :

CDTA is an active circuit element. The CDTA is free from parasitic input capacitances and it can operate in a wide frequency range due to its current-mode operation. CDTA

consists of the input current-differencing unit and of multiple-output OTA (Operational Trans conductance Amplifier) [3, 4]. Because of high current gain of the CDTA which is comparable to voltage gain of a classical voltage-feedback operational amplifier, the CDTA can be used as a current comparator. The pair of output currents from the x terminals, shown in Figure 4 may have three combinations of directions:

1. Both currents can flow out.
2. The currents have different directions.
3. Both currents flow inside the CDTA element

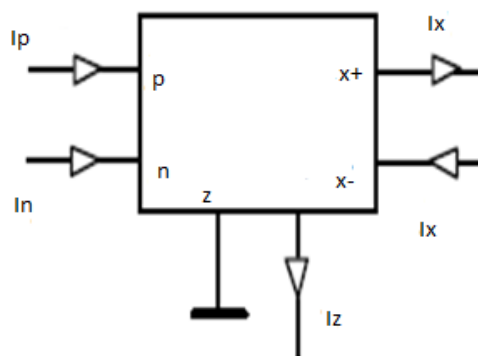

Figure 4 Circuit Symbol of CDTA

The CMOS transistor-level schematic of the proposed CDTA is shown in Figure 5. The current difference consists of transistors M01–M17. The voltage buffers basically provide low-input impedances and also keep the input terminals at ground level. The current mirrors convey the difference of input signals to the z terminal. The transistor M21–M28 of the CDTA consists of a current difference and a dual output operational Trans conductance amplifier (DO-OTA). Ideally DO-OTA is composed of two inverting amplifiers.

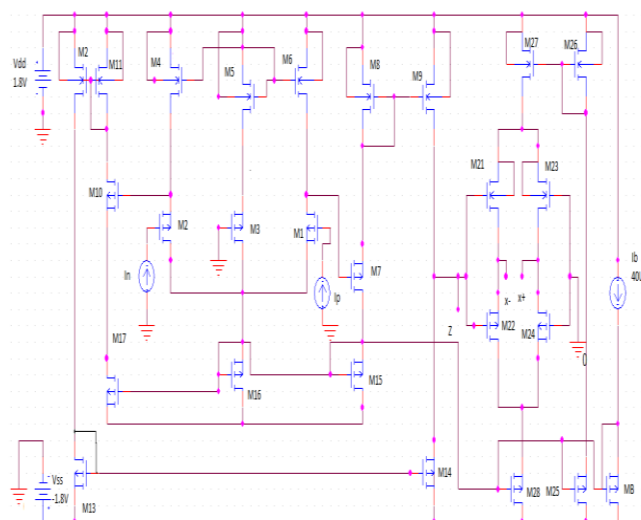

Figure 5: Diagram of Current Differencing Trans conductance amplifier

Simulated Parameters: The simulation of OTA and CDTA is done by the software PSPICE capture. The parameters are shown in table 1

Table 1: Comparison of OTA and CDTA

PARAMETERS	OTA	CDTA
Supply Voltage	1.8V	1.8V
Power dissipation	0.0233 μW	0.031 μW
Unity gain bandwidth product	7.88MHz	17.75 MHz
Slew rate	394.81V/μs	263V/ μs
Common mode rejection ratio	56.7dB	-
Input Impedance	18.33×10 <sup>-4</sup> Ω	3.62×10 <sup>-7</sup> Ω
Gain	44 dB	42.14 dB

The technology used for OTA and CDTA is 350 nm technology and the frequency at which they are operating is 1MHz, the operating supply voltage can be 1.8V. The capacitor to the output attached is having the value of 1pf. Power dissipation is found to be very less μW of OTA and CDTA .The slew rate of OTA is very high than the slew rate of CDTA.

**2.3 Current feedback operational amplifier :** The operational amplifier is called as current feedback operational amplifier (shown in Fig 6) when feedback network samples the output current. A 2.5 V supply voltage for this current feedback is used [5, 6]. The output stage of the op amp is a simple complementary source follower gain with input level shift achieved. The input stage bias current,  $I_b = 100 \mu A$ , which defines the current in M3 and M4 as well as in transistor M5. It can be that the currents can't be equally likely. This is a current source load circuit of differential amplifier in which a dc current flows through both the PMOS transistor and as well as NMOS, the transistor with the larger dc current will become active.

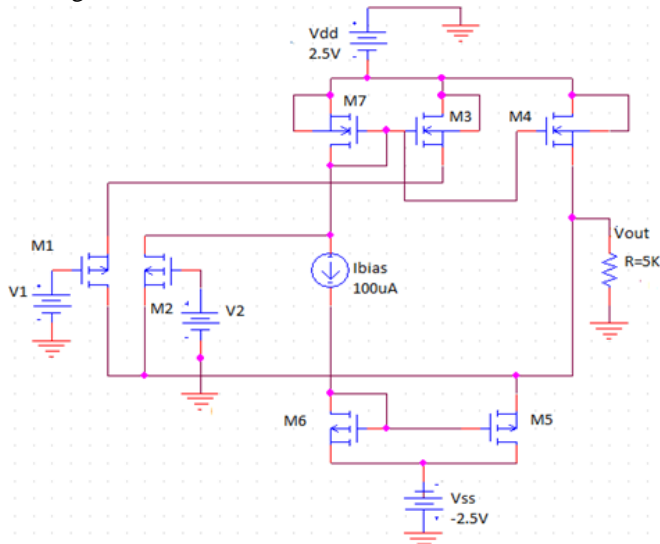

Figure 6 : Diagram of current feedback operational amplifier.

### III. Design of Instrumentation Amplifier

A common theme in instrumentation deals with how to amplify a small differential signal [7, 8]. Take for example the problem of

trying to measure a person's muscle activity. If two probes are placed across a muscle, a small voltage will be generated (order of a few milli-volts). The signal is sent into an A/D converter-

- 1) The signal needs to be amplified to 0-5V in order to reduce the quantization noise resulting from the A/D process.
- 2) The amplifier needs to amplify the difference voltage, rather than amplifying each signal separately and then subtracting.

The symbol for an instrumentation amplifier is as follows:

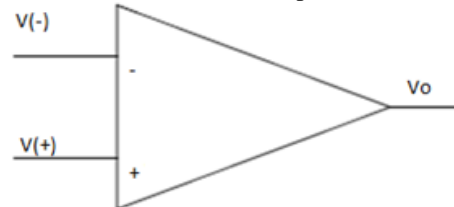

Figure 7: Symbol for an Instrumentation Amplifier

The output is ideally a gain times the differential input-

$$V_o = k(V_+ - V_-)$$

with no gain (k) times the common mode (so that the common mode rejection ratio(CMRR) is infinity). Note that an instrumentation amplifier has the same symbol as an operational amplifier. [9, 10, 11] While this may cause confusion, you can differentiate between the two by looking for feedback resistors. If there is no feedback, the device in the circuit diagram is probably an instrumentation amplifier. If there is a feedback, it is definitely an operational amplifier [12].

#### 3.1 One-Stage Instrumentation Amplifier:

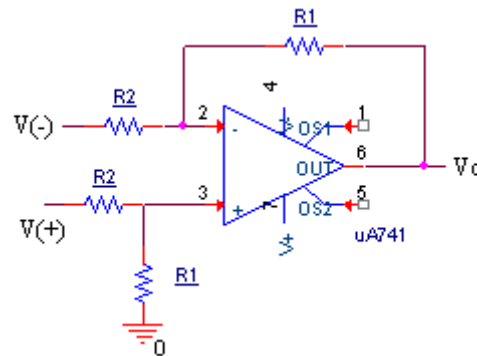

Figure 8: Symbol for one-stage Instrumentation Amplifier

The output for this circuit is

$$V_o = \frac{R_1}{R_2}(V_+ - V_-)$$

#### 3.2 One Stage Instrumentation Amplifier with Input Buffering:

This circuit consists of two input buffers and one differential amplifier. One improvement on this circuit is to add a buffer to the inverting and non inverting inputs. This results in the input impedance going to  $\infty$  (ideal case) but in practical it is in Mega ohms.

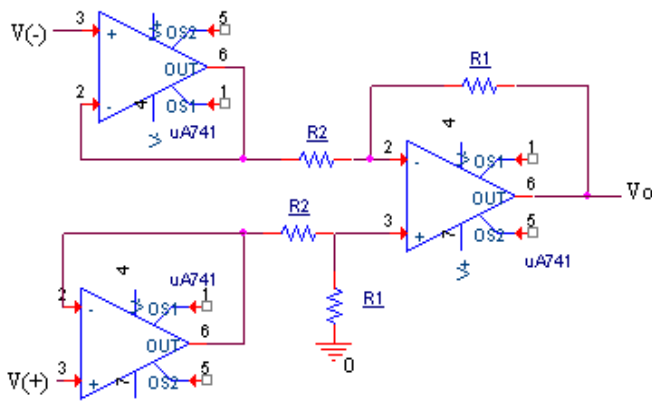

Figure 9: Symbol for one stage Instrumentation Amplifier with Input Buffering

#### IV. Simulation Results

##### 4.1 OTA based INSTRUMENTATION AMPLIFIER

OTA based IA block diagram is shown in Fig 10 which is realized by using two operational Trans conductance amplifier and one current feedback circuit with three resistors  $R_1$ ,  $R_2$  and  $R_{out}$ . We have already designed OTA in Fig. 3 and CFOA in Fig 6 which are clubbed in one circuit using ORCAD CAPTURE and then simulated. Gain, power dissipation, slew rate and CMRR are calculated from the circuit. Simulation parameters are shown in Table 2.

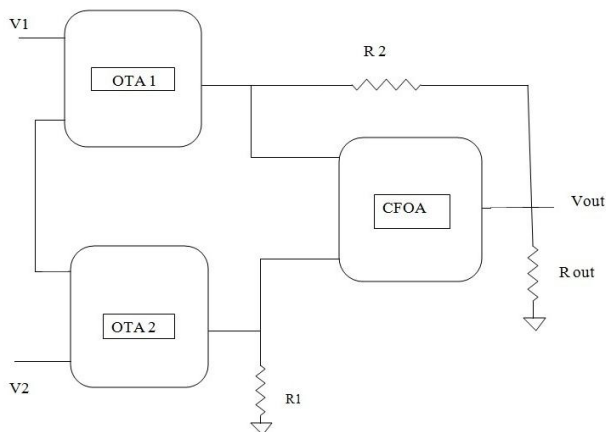

Figure 10: Symbol of OTA based IA

##### 4.2 CDTA based INSTRUMENTATION AMPLIFIER

CDTA based IA block diagram is shown in Fig 11 which is realized using two current differencing Trans conductance amplifier and one current feedback circuit with three resistors  $R_1$ ,  $R_2$ ,  $R_3$ ,  $R_4$ ,  $R_5$  and  $R_6$ . In this circuit,  $V_1$  and  $V_2$  are two input voltages and the other two inputs are connected through a resistor  $R_3$ . The output is at  $R_6$  resistor of value 5K.

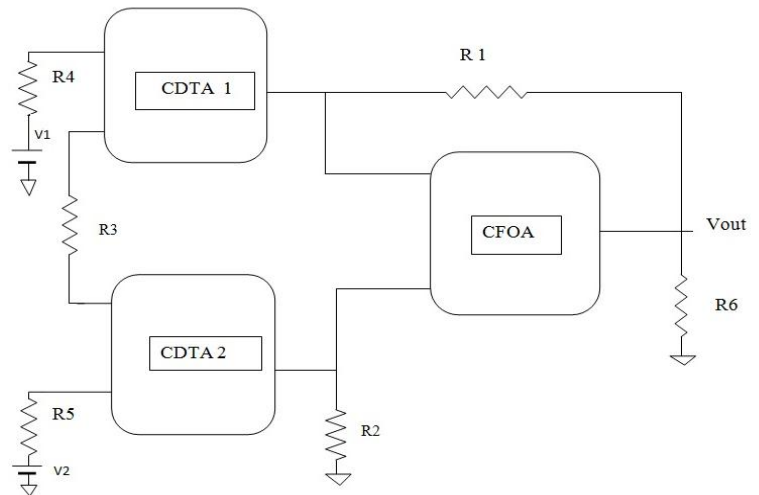

Figure 11: Symbol of CDTA based IA

We have already designed CDTA in Fig. 5 and CFOA in Fig 6 which are clubbed in one circuit using ORCAD CAPTURE and then simulated. Gain, Power dissipation, slew rate and CMRR are calculated from the circuit. Simulation parameters are shown in Table 2.

Table 2: Comparison of OTA with IA and CDTA with IA

PARAMETERS	OTA with IA	CDTA with IA
Supply Voltage	1.8V	1.8V
Power Dissipation	0.077mW	0.0612mW
Gain	24dB	27 dB
Slew Rate	387V $\mu$ s	470.5 V $\mu$ s
Common mode rejection ratio	13dB	36 dB

Table 2 shows that the CDTA implemented Instrumentation amplifier provides better CMRR, slew rate than the implementation of OTA with Instrumentation amplifier. The power dissipated is also less in CDTA implemented Instrumentation amplifier when compared with OTA implemented Instrumentation amplifier. This shows that the better circuit in biomedical application is CDTA instrumentation amplifier.

#### V. Conclusion

In this paper, we have compared different circuits on the basis of the four parameters gain, slew rate, CMRR and power dissipation for the OTA and CDTA both operating at a voltage of 1.8V. The main application of OTA with IA and CDTA with IA is also compared and conclusion being derived is CDTA with IA offers the best combination of high CMRR, high slew rate with less power dissipation, which was not there in the other circuits.

#### Acknowledgement

We would like to sincerely thank Dr. Pradeep K Naik, Associate Professor of the Bioinformatics Department, Jaypee University of Information technology, Wanknaghat, Solan who inspired us to do this work. In addition, our sincere gratitude we would like to thanks DRDO for his financial support and suggestions.

### References

- i. Chia-Hao Hsu, Chi-Chun Huang, Kian Siong Lim, Wei-Chih Hsiao, and Chua-Chin Wang, "A High Performance Current-Balancing Instrumentation Amplifier for ECG Monitoring Systems", *ISOC* 2009 pp 83-86.
- ii. Ahmed H. Madian, Soliman A. Mahmoud, Ahmed M. Soliman, "Low voltage CMOS fully differential current feedback amplifier with controllable 3-dB bandwidth", *Analog Integr Circ Sig Process* (2007) 52:139-146 DOI 10.1007/s10470-007-9108-y.
- iii. J. Bales, "A Low-Power, High-Speed, Current-Feedback Op Amp with a Novel Class AB High Current Output Stage," *IEEE J.*
- iv. Brent J. Maundy, Member, IEEE, Ataur R. Sarkar, and Stephan J. Gift, Member, IEEE, "A New Design Topology for Low-Voltage CMOS Current Feedback Amplifiers", *IEEE Transactions On Circuits And Systems—II: Express Briefs*, Vol. 53, No. 1, January 2006.
- v. Raj Kumar Tiwari, Ganga Ram Mishra and Maheshwar Misra, "A New High Performance CMOS Differential Amplifier" *International Journal of Electronic Engineering Research* ISSN 0975- 6450 Volume 1 Number 2 (2009)
- vi. S. Pennisi, "High-performance CMOS current feedback operational amplifier", in *Proc. IEEE Int. Symp. on Circ. and Syst. (ISCAS)*, II, Kobe, Japan, pp. 1573– 1576 (2005).
- vii. Behnam Babaei and Sattar Mirzakuchaki, K.N.Toosi University of Technology, Tehran, Iran, "High CMRR, Low Power and Wideband Current-Mode Instrumentation Amplifier" *IEEE Norchip* 2006.
- viii. Kimmo Koli and Kari A. I. Halonen, "CMRR Enhancement Techniques for Current-Mode Instrumentation Amplifiers" *IEEE Transactions On Circuits And Systems-I: Fundamental Theory And Applications*, Vol. 47, No. 5, May 2000.
- ix. Philip E Allen, Douglas R Holberg, "CMOS Analog Circuit and Design", 2<sup>nd</sup> Edition, Oxford University Press.
- x. Adel S. Sedra and Kenneth C. Smith, "Microelectronic Circuits – Theory and Applications", 5<sup>th</sup> Edition, 2004, Oxford University Press.
- xi. Behzad Razavi, "Design of Analog CMOS Integrated Circuits", 1<sup>st</sup> Edition, 2001, Tata McGraw Hill.
- xii. R. Jacob Baker, "CMOS Circuit Design and Layout", "Third edition.